

READ ALL INSTRUCTIONS BEFORE ASSEMBLING THIS INFLATABLE DEVICE AND KEEP INSTRUCTIONS FOR FUTURE USE.

FAILURE TO FOLLOW THESE WARNINGS AND INSTRUCTIONS CAN RESULT IN SERIOUS INJURY OR DEATH TO USERS, ESPECIALLY CHILDREN.



WARNING

Prevent Drowning

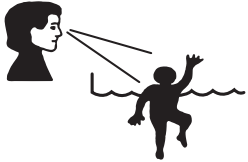

Children...especially toddlers...are at high risk of drowning.

Closely watch children who are in or near this pool. Empty pool or prevent access when not in use.

No Diving



You can break your neck and be paralyzed!

Diving into shallow water can result in a broken neck, paralysis, or death.

Children, especially toddlers, are at high risk of drowning. Closely watch children who are in or near this constant air inflatable. Assign an adult to supervise the constant air inflatable.

Empty constant air inflatable or prevent access when not in use. Store the empty constant air inflatable in such a way that it does not collect water from rain or any other source.

Safety Section

Drowning Risk:

Prevent young children from drowning.

Keep unsupervised children from accessing the constant air inflatable by installing fencing or other approved barrier around all sides of constant air inflatable. State or local laws or codes may require fencing or other approved barriers. Check state or local laws and codes before setting up constant air inflatable.

Drowning occurs silently and quickly and can occur in as little as 2 in. (5 cm) of water.

Keep children in your direct sight, stay close, and actively supervise them when they are in or near this constant air inflatable and when you are filling and emptying this constant air inflatable.

When searching for a missing child, check the constant air inflatable first, even if child is thought to be in the house.

Remove constant air inflatable ladders before leaving the constant air inflatable. Children as young as 2 years have climbed up ladders and into constant air inflatable and drowned.

Do not leave toys inside pool when finished using, since toys and similar items might attract a child to the constant air inflatable.

Position furniture (for example, tables, chairs) away from constant air inflatable and so that children cannot climb on it to gain access to the constant air inflatable.

After using constant air inflatable, remove water to a level of 1/2 in. (1 cm) or less.

Diving Risk:

No diving. You can break your neck and be paralyzed!

Electrocution Risk:

Keep all electrical lines, radios, speakers and other electrical appliances away from the constant air inflatable.

Do not place constant air inflatable near or under overhead electrical lines.

First Aid:

Keep a working phone and a list of emergency numbers near the constant air inflatable.

Become certified in cardiopulmonary resuscitation (CPR). In the event of an emergency, immediate use of CPR can make a lifesaving difference.

CAI

Banzai®

SLIDE 'N SOAK SPLASH PARK™

The product should be periodically examined for conditions that may result in the risk of fire, electric shock, or injury to persons and that, in an event such conditions, the product should not be used until properly repaired.

IMPORTANT SAFETY INSTRUCTIONS. PLEASE READ AND SAVE THESE INSTRUCTIONS CAREFULLY BEFORE USING THIS PRODUCT.

WARNING!

To Reduce the Risk of Fire or Electric Shock. Do Not Use This Blower with Any Solid-State Speed Control Device. Warn the user to unplug or disconnect the appliance from the power supply before servicing.

DANGER

To prevent electric shock, do not immerse the blower in water, wipe clean with damp cloth.

Do not operate any fan with a damaged cord or plug. Discard fan or return to an authorized service facility for examination and/or repair.

Do not run cord under carpeting. Do not cover cord with throw rugs, runners, or similar coverings. Do not route cord under furniture or appliances. Arrange cord away from traffic area and where it will not be tripped over.

CAUTION - ELECTRICALLY OPERATED PRODUCT

Operation of Blower Fan Unit not recommended for children under 14 years of age. As with all electric products, precautions should be observed during handling and use to prevent electric shock.

AGES 5-12

 **WARNING:**
CHOKING HAZARD - Small parts.
Not for children under 3 yrs.

SAFETY PRECAUTIONS

WARNING! Failure to follow these instructions could result IN SERIOUS INJURY OR DEATH.

CHILDREN MUST HAVE ADULT SUPERVISION WHEN PLAYING WITH THIS PRODUCT. NEVER LEAVE CHILDREN UNATTENDED.

- NOT FOR ADULT USE. NOT FOR CHILDREN OVER 12 OR UNDER 5 YEARS OF AGE. THIS PRODUCT IS NOT FOR USE BY ANYONE WEIGHING OVER 120 lb (54 kg).
- Platform:
Individual user maximum weight limit: 120 lb (54 kg)
Combined user maximum weight limit: 150 lb (68 kg)
- Whole Product:
Total weight limit: 600 lb (270 kg)
Total no. of users : 5
- The maximum fall height is 56 in (142 cm).
- For outdoor use.
- Keep away from fire.
- To prevent electrical shock or damage to blower, do not pour water on it and never leave outdoors overnight.
- Keep the blower away from water.
- Keep children away from blower.
- Remove shoes, eyeglasses, and sharp objects before playing with the product.
- No flipping, piling, pushing or wrestling when playing with the product.
- Only one child should be on the platform at a time.
- Only one child should climb up the climbing wall at a time.
- Do not curl the water hose.
- Do not play on the slide without filling the pool with at least 8 in (20 cm) of water. Thoroughly wet all slide surfaces, platforms and climbing walls before use to ensure optimal play performance.
- No diving of any sort is safe.
- Always dry the product thoroughly before storing. Can cause mildew if stored damp.

SET UP:

- Adult assembly required.
- NOT FOR COMMERCIAL USE. This product is intended for family domestic use only.
- Place and use on level ground.
- Do not set up or use in windy, snowy or rainy weather.
- Do not set up or use on concrete, asphalt or any other hard surfaces.
- Use on flat lawn only, not pavement or other hard surfaces. Lawn should be free of rocks, bumps, depressions, sticks, etc.
- Set up a safe distance from fences, garages, houses, walls, water, overhanging branches, laundry lines, overhanging electrical wires and other obstructions.
- To prevent product from becoming unstable and the possibility of serious injury or death, do not play on the product until it is completely filled with air and anchored properly.
- The design of the constant air inflatable requires a fair amount of air to emit from its porous fabric material. This ensures that the product remain inflated while allowing it to resist small tears and punctures.
- To anchor the product properly, ALWAYS anchor the product and blower with corresponding ground stakes before use.
- Keep the blower and power cord away from water.
- To extend the life of the product, do not leave the product in the sun when not in use.

SLIDING INSTRUCTIONS:

- Get wet before sliding.
- Do not stand on the top of the slide, on the slide rails, or on the slide itself.
- Climb up the climbing wall of the slide and sit at the top of the slide with your feet pointing down the slide. Scoot forward and slide down the slide feet first.
- To avoid the risk of serious injury or death, always slide with your feet first and never slide on your knees, stomach, or head first. Do not jump off or dive off the slide.
- Only one child should slide down the slide at a time.
- Never slide while facing direct sunlight.
- To avoid possible serious injury, the sliding path and landing area must be clear of all obstacles and other users before sliding.
- When sliding into the pool, the entering area should be clear of all submerged obstacles, non-submerged obstacles and other users.
- Do not jump off or dive off the slide into the pool to avoid the risk of serious injury or death.
- Do not jump off or dive off the climbing wall into the pool to avoid the risk of serious injury or death.

REPAIR PATCH INSTRUCTIONS

For your convenience, a repair patch has been included to repair holes in the inflatable section. In the event of an accidental puncture, cut out a suitably sized patch. Make sure you round the corners of your repair patch to avoid peeling. Make sure area to be patched is clean. Press patch firmly over the puncture. Do not inflate for 30 minutes.

WARNING

While every attempt is made to embody the highest degree of protection in all equipment, we cannot guarantee freedom from injury. The user assumes all risk of injury due to use. All merchandise is sold on this condition, which no representative of the company can waiver or change.

INTRODUCTION

Suit up and get drenched on the Slide 'N Soak Splash Park™ ! Make your way up the side-climbing wall and race down the water slide before landing with a giant splash in the refreshing lagoon-style pool. Or cool off under the overhead shower sprinkler. With the included continuous airflow blower, all of this fun inflates in under 2 minutes. Heavy-duty Dura-Tech™ construction ensures lasting strength and durability. What are you waiting for? Unfold, inflate, and have fun!

SETUP INSTRUCTIONS

PLACEMENTS: Use on flat lawn only, not pavement or other hard surfaces. Lawn should be free of rocks, bumps, depressions, sticks, etc. The product should be set up in a location that has a minimum distance of 10 ft (305 cm) from any free standing structures or obstructions, including: houses, garages, fences, trees, playground equipment, and large rocks.

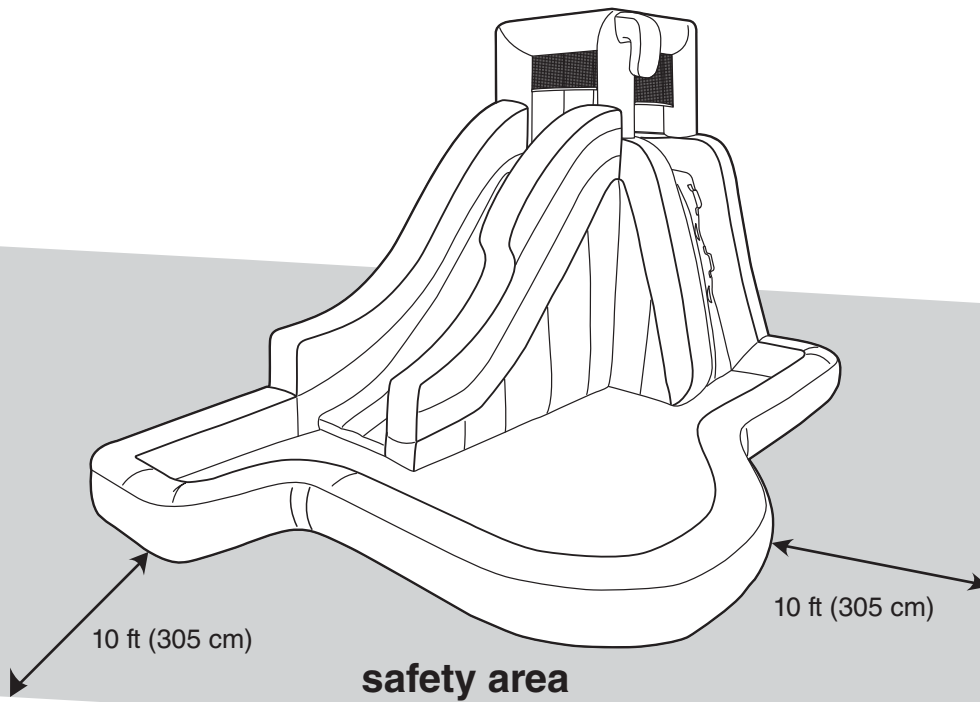

SETUP

1. Unfold the constant air inflatable in a desired position on a smooth and level surface.
2. Layout the water hose assembly and match the number on each sprayer to the correct position on the arch of the inflatable. Once the numbers are matched, attach the sprayers to the arch and corresponding position using the Velcro patches provided. Secure the water tubing using the

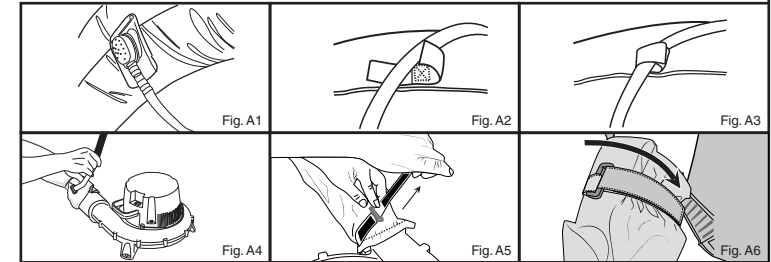

3. Attach the long intake tube at the back of the inflatable to the mouth of the blower motor using the attached Velcro Strap. To ensure a secure fit, wrap the strap around the mouth of the blower and tightly attach the self-sticking strap. (Fig A4-A6)
4. Tie the short air release tube closed with the drawstring provided. (Fig A7)
5. Position the blower in a straight line perpendicular and level to the back of the inflatable. The blower should be placed on a stable surface and remain upright after the inflatable is inflated. The blower is a high volume fan capable of moving a lot of air very quickly. Place the blower in an area where it will not suck in dirt or leaves. Keep blower away from children, water and moving vehicles. Set up inflatable far away from any structures or obstructions. Once positioned, secure the blower with the blower ground stakes provided. (Fig A8)
6. Do not set up over concrete, asphalt, packed earth, or any other hard surfaces. A fall onto a hard surface can result in serious injury.
7. Locate the loops around the bottom of the inflatable and anchor them to the turf, sand soil or rock soil with the water slide ground stakes provided. (Fig A9)
8. Ground stakes must be completely inserted into the ground so that no part of the stake is protruding above the ground surface. This will help prevent tripping or injuries resulting from a fall.
9. Plug the blower into a properly grounded outlet and turn it on. The inflatable should inflate in under 2 minutes. Do not allow children to use the inflatable until it is fully inflated.
10. Close the water valve at the bottom of the pool. (Fig A10)
11. Fill the pool with at least 8 in (20 cm) of water before playing. Thoroughly wet all slide surfaces, platforms and climbing walls before use to ensure optimal play performance.
12. Do not fill the product tub to more than the maximum fill line marked inside the pool wall.
13. After inflation, the blower should run continuously while children are playing.

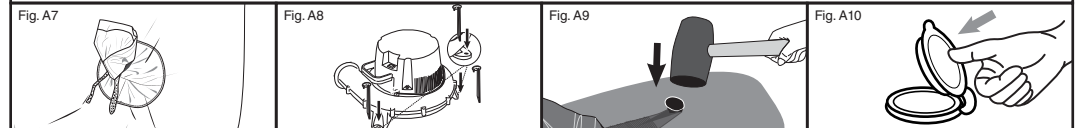

SLIDE 'N SOAK SPLASH PARK™ SETUP DIAGRAM

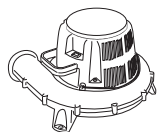

Blower Motor



**Water Spraying
Hose Assembly**

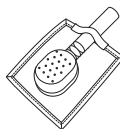

**Water Spraying
Hose Assembly**



**Water Slide
Ground Stakes**



**Blower Ground
Stakes**

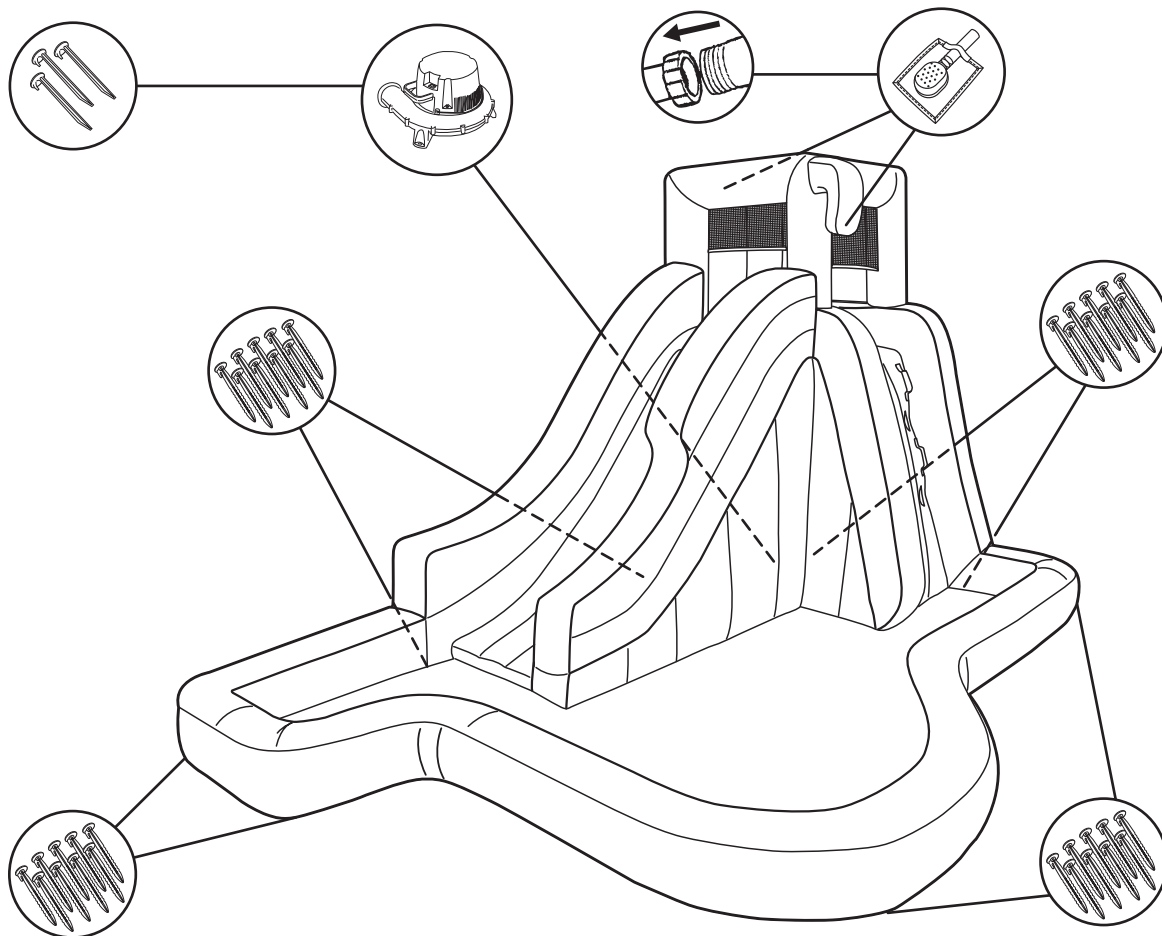

CONNECTING THE WATER HOSE

1. Wet the inflatable before connecting the garden hose to the hose adapter.
2. Locate the end of the Water Spraying Hose Assembly that should be attached to the inflatable.
3. Attach the screw cap on the hose assembly to your garden hose.
4. Turn on the water slowly. It may take a few moments until water begins to spray.
5. Adjust the water pressure so that the water sprays on the sliding surface of the inflatable, keeping the inflatable wet.

IMPORTANT WATER PRESSURE AND OPERATING INFORMATION

Water pressure can vary dramatically between cities. Please read the following to answer some common questions.

Areas of LOW WATER PRESSURE:

- For maximum performance, it is recommended to use a 5/8 in (1.6 cm) diameter garden hose.
- If water does not arch on the slide or shoot properly. This is usually due to low water pressure, make sure the water is on all the way. As long as the slide is getting wet, it will be fun to use.
- Long hoses reduce water pressure: The longer the hose, the farther the water travels from the faucet thus reducing water pressure. In areas of low water pressure, this could affect performance of the water spray. Try using a shorter hose if you have one.

Areas of HIGH WATER PRESSURE:

- If water shoots over the slide, adjust the faucet to lower the water pressure. It is important that the water lands on the slide to keep it wet and slick.

HOW TO USE

1. Follow all setup instructions to ensure the product has been set up properly.
2. Remove shoes, eyeglasses, and sharp objects before playing with product.
3. No flipping, piling, pushing or wrestling when playing with the product.
4. Only one child should be on the platform at a time.
5. Only one child should climb up the climbing wall at a time.
6. No diving of any sort is safe.
7. Get wet before sliding.
8. Do not stand on the top of the slide, on the slide rails, or on the slide itself.
9. Climb up the climbing wall of the slide and sit at the top of the slide with your feet pointing down the slide. Scoot forward and slide down the slide feet first.
10. To avoid the risk of serious injury or death, always slide with your feet first and never slide on your knees, stomach, or head first. Do not jump off or dive off the slide.
11. Only one child should slide down the slide at a time.
12. Never slide while facing direct sunlight.
13. To avoid possible serious injury, the sliding path and landing area must be clear of all obstacles and other users before sliding.
14. When sliding into the pool, the entering area should be clear of all submerged obstacles, non-submerged obstacles and other users.
15. Do not jump off or dive off the slide into the pool to avoid the risk of serious injury or death.
16. Do not jump off or dive off the climbing wall into the pool to avoid the risk of serious injury or death.
17. Adult supervision is required to ensure observation of all parts of the play area, all activity on the inflatable device and keeping the entrance free from obstruction at all times.

AFTER SLIDING

After you have finished sliding, exit the splash pool and stand up on the grass.

To avoid danger of tripping over the air intake tube and causing potential injury, do not walk on the side of the inflatable that has the blower motor attached. Always walk around the inflatable as shown with the dotted line in the diagram below.

Never stand, walk, or run on the slides as you may slip and injure yourself.

There should be a clear and unobstructed path along the walking paths. Make sure that the blower motor does not interfere with the walking paths.

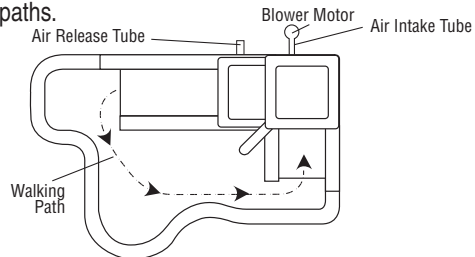

EMERGENCY EVACUATION

For emergency evacuation, users should evacuate through the exit and walk to a safe location as shown with the dotted lines in the diagram below. To avoid danger of tripping over the air intake tube and causing potential injury, do not walk on the side of the inflatable that has the blower motor attached.

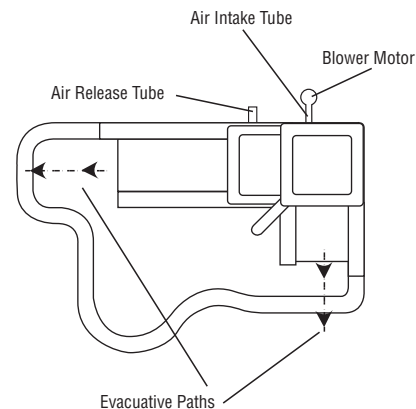

SAFETY CHECKLIST: READ BEFORE USING

SET UP:

1. Before set up: Check under and around the inflatable for sharp objects, rocks, sticks, lawn sprinklers or any other object that can cause injury or damage the inflatable. Set up on a flat lawn surface, free of depressions or high spots.
2. Use with manufacturer-supplied stakes ONLY.
3. Areas immediately adjacent to all areas of access egress of the inflatable device 15 ft 4 in L x 9 ft 6 in W x 7 ft 11 in H (467 cm L x 290 cm W x 241 cm H) shall have use zones, which are free of obstacles and covered with impact attenuating surfacing for a minimum distance of at least 10 ft (305 cm).
4. Do not use a damaged inflatable.
5. Wet entire slide before connecting the hose to the inflatable and before playing.
6. Blower motor and electrical cords should not pass under the inflatable and interfere with its operations.
7. Blowers and electrical cords shall be positioned at least 4.3 ft (1.3 m) from a walled side of the inflatable device and 8.2 ft (2.5 m) from an open side.
8. The product shall be inflated with blower provided or with other manufacturer specified replacement blower.

USE:

1. Adult setup and supervision is required at all times. Adults should read instruction manual entirely and instruct children on proper use of this inflatable.
2. Get bathing suits or clothing wet before using the product. Remove all hard or sharp objects from person and pockets, such as toys, buckles, keys, jewelry, watches, etc.
3. For long periods of play, move inflatable occasionally to prevent depressions in ground underneath.
4. Check all ground stakes occasionally to make sure they stay secure and flat in the ground.
5. Do not leave water hose turned on when you are not using the inflatable. Only turn it on when playing.
6. While playing with the inflatable, it is normal for some water to seep into the interior through the seam areas. IT IS IMPORTANT to completely dry prior to storing.
7. The sliding path must be clear of users before sliding.

Proper Use of Product:

1. Separation of larger children from smaller children.
2. Prevention of users from climbing or hanging on the containing walls.
3. Prevention of inappropriate activities (for example, somersaults and rough play).
4. Restrictions on the consumption of food, drink and gum.
5. Correct use position of inflatable device (for example, on slide, climbing wall).
6. Keep pets off of the inflatable device.
7. Do not attach items to the inflatable device that are not specifically designed for use with the inflatable device, such as, but not limited to, jump ropes, clothesline, pet leashes, cables and chain as they have the potential to cause a strangulation hazard.

NOTE:

- Check your local country or city regulations for requirements on securing the pool.
- Secure the pool from unauthorized use.

BLOWER OPERATING INSTRUCTIONS

INTENDED USE:

This product is only to be used for inflating the Slide 'N Soak Splash Park™. Household Use only.

WARNING:

1. Electrical current requirements:110-120VAC/60Hz
2. The power supply to the blower should include a reliable earth terminal and current leakage protection device.
3. The power cord to the appliance should be clearly marked, so that persons using lawn mowers or other types of equipment are aware that there is a cord on the ground.
4. The blower should never be left unattended when in use. The appliance is not to be used by children.
5. No objects should cover the air intake when the blower is in use. Sand, small stones or other objects should not be allowed to be sucked into the blower.
6. Under no circumstances should a finger or any sharp object be inserted into the air intake.
7. The power supply to the blower should not be exchanged for any other type of supply. If the power supply is damaged, it should be repaired by a technician.
8. To avoid the danger of electrical shock, do not use the blower in the rain.
9. Do not use extension cords as this would present an electrocution hazard.
10. Do not leave the blower exposed to strong sunlight.
11. Children should not touch the blower. Children must not play on the product until the blower is properly installed.
12. Children should not attach foreign objects to the blower that are not specifically designed for use with the blower, such as, but not limited to jump ropes, clothesline, pet leashes, cables and chain as they may cause a strangulation hazard.

13. Sudden gusts of wind may lift the product off of the ground.
14. Blowers and electrical cords should be kept out of reach.
15. The product shall be inflated with blower provided or with other manufacturer specified replacement blower.

INSTALLATION:

1. Place the blower on the ground and then secure it by inserting the ground stakes into the holes in the base.
2. The blower should be installed in a well-ventilated location and on a level surface.
3. The air input of the product (the long intake tube) is to be attached to the air output of the blower and secured in place with a cord.

USING THE BLOWER:

1. Plug the blower into a power supply.
2. To avoid electrical shock, never plug in or unplug the appliance with wet hands.
3. The power supply should be disconnected if the blower or the product needs to be transported or moved.
4. There is an ON/OFF switch on the blower body. Press "I" to switch on the blower, and press "O" to switch off the blower.

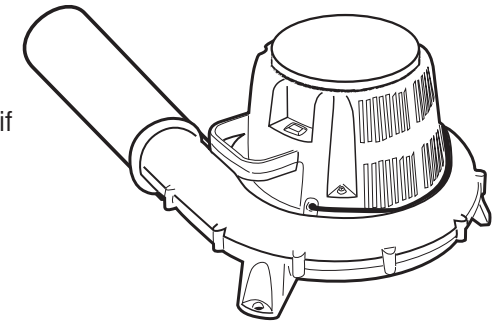

PART LIST

1. 1 x Inflatable Water Slide
2. 1 x Blower Motor
3. 1 x Water Spraying Hose Assembly
4. 3 x Blower Ground Stakes
5. 8 x Water Slide Ground Stake + 1 Extra
6. 1 x Carrying Bag
7. 4 x Repair Patches

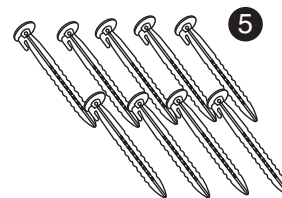
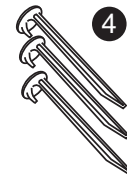
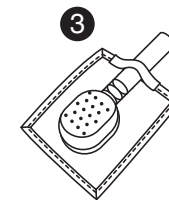
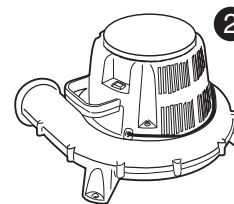
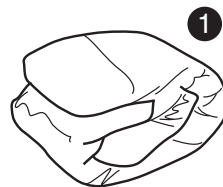

Attn: Each time the blower is used, a simple test with the Ground Fault Circuit Interrupter (GFCI) must be conducted.

1. Push the "Reset" button located on the GFCI receptacle, first to assure normal blower and GFCI operation.
2. Press "I" to switch on the blower.
3. Push the "Test" button located on the GFCI receptacle. The blower should go "OFF".
4. Push the "Reset" button again. The blower should go "ON" again.

The indicator on the GFCI receptacle will be red whenever the "Reset" button is pressed.

If the blower remains "ON" when the "Test" button is pushed, the blower or GFCI is not working properly. If blower or GFCI is not working properly, please call a qualified, certified electrician who can assess the situation.

Maintenance and Storage:

1. To keep the product clean you can use a dry cloth or a cloth dampened with a neutral, non-inflammable, nontoxic cleaning and sanitizing solution or pure water to wipe the surface of the blower.
2. You should not clean the blower with a chemical solution as this may damage the coating and plastic parts.
3. Never clean the blower in water.
4. Never store the blower outside. Keep it in a dry indoor place unreachable by children.
5. Regularly check the condition of the blower stakes. Damage to or deterioration of the stakes could result in the blower becoming unstable which could result in serious injury.
6. Regularly check the condition of the power cord. Damage to or deterioration of the cord could cause a serious electrocution hazard. If the cord is damaged or deteriorated, immediately discontinue use of the blower and contact the manufacturer.
7. This blower with Auto-Reset Protector, if the motor over heated, the protector will trip to protect your safety. Turn off the blower and let it cool down. Then, you can use it again. Please follow the instruction carefully to avoid any wrong operation that will cause overheating.
8. To keep the power cord in good condition, hand-supported product when carry the power cord, and do not twisting the cord, keep it dry and store it dry.

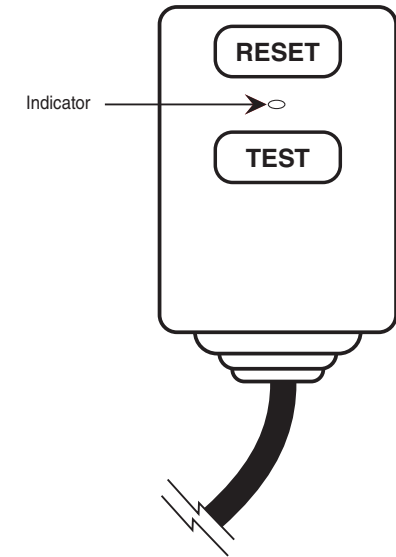

ALL NEW MATERIAL. Surface Clean Only. Electrical ratings: 110-120VAC, 60Hz, 3.3A



WARNING - Electrocution Hazard
DO NOT USE EXTENSION CORDS
WITH THIS PRODUCT.



BEFORE RETURNING TO STORE
PLEASE VISIT THE CUSTOMER SERVICE WEBSITE
BELOW FOR IMMEDIATE ASSISTANCE REGARDING
QUESTIONS OR PROBLEMS WITH THIS PRODUCT.

www.toysinquiry.com

NOTE: The maximum wind speed for operations of the inflatable shall be 20 mph.

PANZAI

90321

TANG RONG ROAD,
CHANGPING, DONGGUAN, CHINA
ALL RIGHTS RESERVED
MADE IN CHINA
www.toysinquiry.com
CONTENTS AND SPECIFICATIONS MAY
VARY FROM THOSE ILLUSTRATED.