



Drop-Off Falls WATER PARK™

**READ AND FOLLOW ALL SAFETY INFORMATION AND INSTRUCTIONS.
KEEP FOR FUTURE REFERENCE.**

**FAILURE TO FOLLOW THESE WARNINGS AND INSTRUCTIONS CAN RESULT IN
SERIOUS INJURY OR DEATH TO USERS, ESPECIALLY CHILDREN.**

WARNING



Children, especially children younger than five years, are at high risk of drowning. Drowning occurs silently and quickly and can occur in as little as 2 in. (5 cm) of water. Keep children in your direct sight, stay close, and actively supervise them when they are in or near this pool and when you are filling and emptying this pool. When searching for a missing child, check the pool first, even if child is thought to be in the house. Empty pool completely after each use and store the empty pool in such a way that it does not collect water from rain or any other source.

Safety Section:
Drowning Risk:
 Keep unsupervised children from accessing the pool by installing fencing or other approved barrier around all sides of pool. State or local laws or codes may require fencing or other approved barriers. Check state or local laws and codes before setting up pool.
 Remove pool ladders before leaving the pool. Children as young as 2 years have climbed up ladders and into pools and drowned.
 Do not leave toys inside pool when finished using, since toys and similar items might attract a child to the pool.
 Position furniture (for example, tables, chairs) away from pool and so that children cannot climb on it to gain access to the pool.
 After using pool, remove water to a level of 1/2 in. (1 cm) or less.
Diving Risk:
 Do not dive into this pool. Diving into shallow water can result in a broken neck, paralysis, or death.
Electrocution Risk:
 Keep all electrical lines, radios, speakers and other electrical appliances away from the pool.
 Do not place pool near or under overhead electrical lines.
First Aid:
 Keep a working phone and a list of emergency numbers near the pool.
 Become certified in cardiopulmonary resuscitation (CPR). In the event of an emergency, immediate use of CPR can make a lifesaving difference.

The product should be periodically examined for conditions that may result in the risk of fire, electric shock, or injury to persons and that, in an event such conditions, the product should not be used until properly repaired.

IMPORTANT SAFETY INSTRUCTIONS. PLEASE READ AND SAVE THESE INSTRUCTIONS CAREFULLY BEFORE USING THIS PRODUCT.

WARNING! To Reduce The Risk Of Fire Or Electric Shock. Do Not Use This Blower With Any Solid-State Speed Control Device. Warn the user to unplug or disconnect the appliance from the power supply before servicing.

DANGER To prevent electric shock, do not immerse the blower in water, wipe clean with damp cloth.

Do not operate any fan with a damaged cord or plug. Discard fan or return to an authorized service facility for examination and/or repair.

Do not run cord under carpeting. Do not cover cord with throw rugs, runners, or similar coverings. Do not route cord under furniture or appliances. Arrange cord away from traffic area and where it will not be tripped over.

CAUTION - ELECTRICALLY OPERATED PRODUCT

Operation of Blower Fan Unit not recommended for children under 14 years of age. As with all electric products, precautions should be observed during handling and use to prevent electric shock.

AGES 5+



Safety Precautions

WARNING! Failure to follow these instructions could result IN SERIOUS INJURY OR DEATH.

CHILDREN MUST HAVE ADULT SUPERVISION WHEN PLAYING WITH THIS PRODUCT.

NEVER LEAVE CHILDREN UNATTENDED.

- Children must be at least 5 years old to use this product.
- Individual user maximum weight limit: 120 lbs (54kg).
- Combined user maximum weight limit: 150 lbs (68kg).
- The maximum fall height is 62 in (157cm).
- For outdoor use.
- Keep away from fire.
- To prevent electrical shock or damage to blower, do not pour water on it and never leave outdoors overnight. Keep the blower away from water.
- Keep children away from blower.
- Remove shoes, eyeglasses, and sharp objects before playing with product.
- No flipping, piling, pushing or wrestling when playing with the product.
- Only one child should be on the platform at a time.
- Only one child should climb up the climbing wall at a time.
- Do not curl the water hose.
- Do not play on the slide without filling the pool with at least 8in (20cm) of water. Thoroughly wet all slide surfaces, platforms and climbing walls before use to ensure optimal play performance.
- No diving of any sort is safe.
- Always dry Drop-Off Falls WATER PARK thoroughly before storing. Can cause mildew if stored damp.

SET UP:

- Adult assembly required.
- NOT FOR COMMERCIAL USE. This product is intended for family domestic use only.
- Place and use on level ground.
- Do not set up or use in windy, snowy or rainy weather.
- Do not set up or use on concrete, asphalt or any other hard surfaces.
- Use on flat lawn only, not pavement or other hard surfaces. Lawn should be free of rocks, bumps, depressions, sticks, etc.
- Set up a safe distance from fences, garages, houses, walls, water, overhanging branches, laundry lines, overhanging electrical wires and other obstructions.
- To prevent product becoming unstable and the possibility of serious injury or death, do not play on the product until it is completely filled with air and anchored properly.
- The design of the constant air slide requires a fair amount of air to emit from its porous fabric material. This ensures that the slide remain inflated while allowing it to resist small tears and punctures.
- To anchor the product properly, **ALWAYS anchor the product and blower with corresponding ground stakes before use and make sure the water weight bags have been filled with water and attached to the slide using the plastic connectors.**
- Keep the blower away from water.
- To extend the life of the product, do not leave the product in the sun when not in use.

SLIDING INSTRUCTIONS:

- Get wet before sliding.
- Do not stand on the top of the slide, on the slide rails, or on the slide itself.
- Climb up the climbing wall of the slide and sit at the top of the slide with your feet pointing down the slide. Scoot forward and slide down the slide feet first.
- To avoid the risk of serious injury or death, always slide with your feet first and never slide on your knees, stomach, or head first. Do not jump off or dive off the slide.
- Only one child should slide down the slide at a time.
- Never slide while facing direct sunlight.
- To avoid possible serious injury, the sliding path and landing area must be clear of all obstacles and other users before sliding.
- When sliding into the pool, the entering area should be clear of all submerged obstacles, non-submerged obstacles and other users.
- Do not jump off or dive off the slide into the pool to avoid the risk of serious injury or death.
- Do not jump off or dive off the climbing wall into the pool to avoid the risk of serious injury or death.

Repair Patch Instructions

For your convenience, a repair patch has been included to repair holes in the inflatable section. In the event of an accidental puncture, cut out a suitably sized patch. Make sure you round the corners of your repair patch to avoid peeling. Make sure area to be patched is clean. Press patch firmly over the puncture. Do not inflate for 30 minutes.

Warning

While every attempt is made to embody the highest degree of protection in all equipment, we cannot guarantee freedom from injury. The user assumes all risk of injury due to use. All merchandise is sold on this condition, which no representative of the company can waiver or change.

Introduction

Look out below! Make your way up the side-climbing wall and plunge down the slide—whoa! Nothing prepares you for the drop-and-bounce thrills of the Drop-Off Falls Water Park. Land with a splash in pool before scaling up the climbing wall to do it all over again! With the included continuous airflow blower, all of this fun inflates in less than 3 minutes. Heavy-duty Dura-Tech™ construction ensures lasting strength and durability. Take the plunge and bounce into some summer fun!

Setup Instructions

Placement:

Use on flat lawn only, not pavement or other hard surfaces. Lawn should be free of rocks, bumps, depressions, sticks, etc.

Drop-Off Falls WATER PARK™ should be set up in a location that has a minimum distance of 10 ft (305cm) from any free standing structures or obstructions, including: houses, garages, fences, trees, playground equipment, and large rocks.

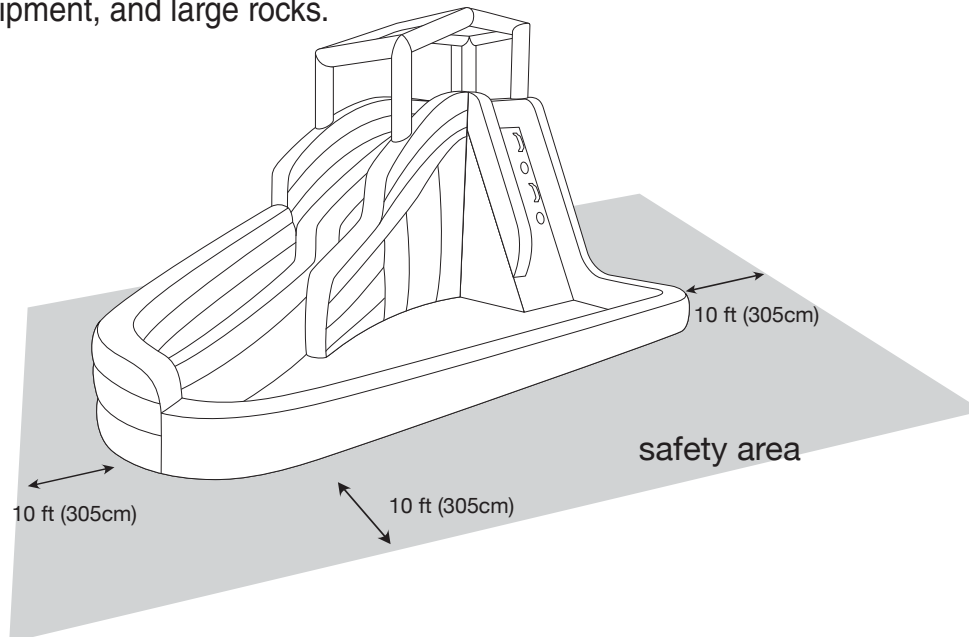

Set up

1. Unfold the inflatable slide in a desired position on a smooth and level surface.
2. Layout the water hose assembly and match the number on each sprayer to the correct position on the arches of the slides. Once the numbers are matched, attach the sprayers to the arches using the Velcro patches provided. Secure the water tubing using the Velcro hooks & loops located on top of the arches and down the side of the inflatable slides. (Fig A1-A3)

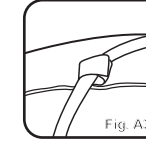
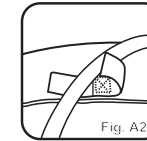
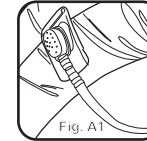

3. Attach the long intake tube at the back of the slide to the mouth of the blower motor using the attached Velcro Strap. To ensure a secure fit, wrap the strap around the mouth of the blower and attach the Velcro tightly. (Fig A4-A6)

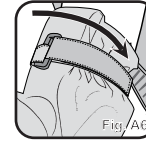
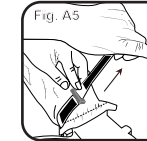

4. Tie the short air release tube closed with the drawstring provided. (Fig A7)
5. Position the blower in a straight line perpendicular and level to the back of the slide. The blower should be placed on a stable surface and remain upright after the slide is inflated. The blower is a high volume fan capable of moving a lot of air very quickly. Place the blower in an area where it will not suck in dirt or leaves. Keep blower away from children, water and moving vehicles. Set up slide far away from any structures or obstructions. Once positioned, secure the blower with the orange ground stakes provided. (Fig A8)
6. Do not set up over concrete, asphalt, packed earth, or any other hard surfaces. A fall onto a hard surface can result in serious injury.
7. Locate the loops around the bottom of the slide and anchor them to the ground with the large yellow ground stakes provided. (Fig A9)

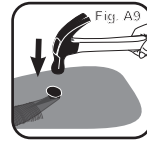
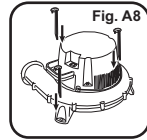

8. Ground stakes must be completely inserted into the ground so that no part of the stake is protruding above the ground surface. This will help prevent tripping or injuries resulting from a fall.
9. Plug the blower into a properly grounded outlet and turn it on. The slide should inflate in less than 2 minutes. Do not allow children to use the slide until it is fully inflated.
10. Connect the anchor bags to the side of the water slide, then fill bags with water until full and close the caps.

Attn: Each Anchor bag should be filled with 40lbs (18kg) of water. Each anchor bag must be attached while using the slide.

11. Close the water valve at the bottom of the pool. (Fig A10)
12. **Fill the pool with at least 8in (20cm) of water before playing. Thoroughly wet all slide surfaces, platforms and climbing walls before use to ensure optimal play performance.**
13. Do not fill the product tub to more than the maximum fill line marked inside the pool wall.
14. After inflation, the blower should run continuously while children are playing.

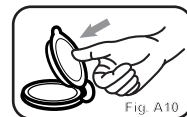

Drop-Off Falls WATER PARK™ Setup Diagram



Blower Motor



Water slide Ground Stakes



Water Spraying Hose Assembly



Blower Ground Stakes



Water Spraying Hose Assembly



Water Bags

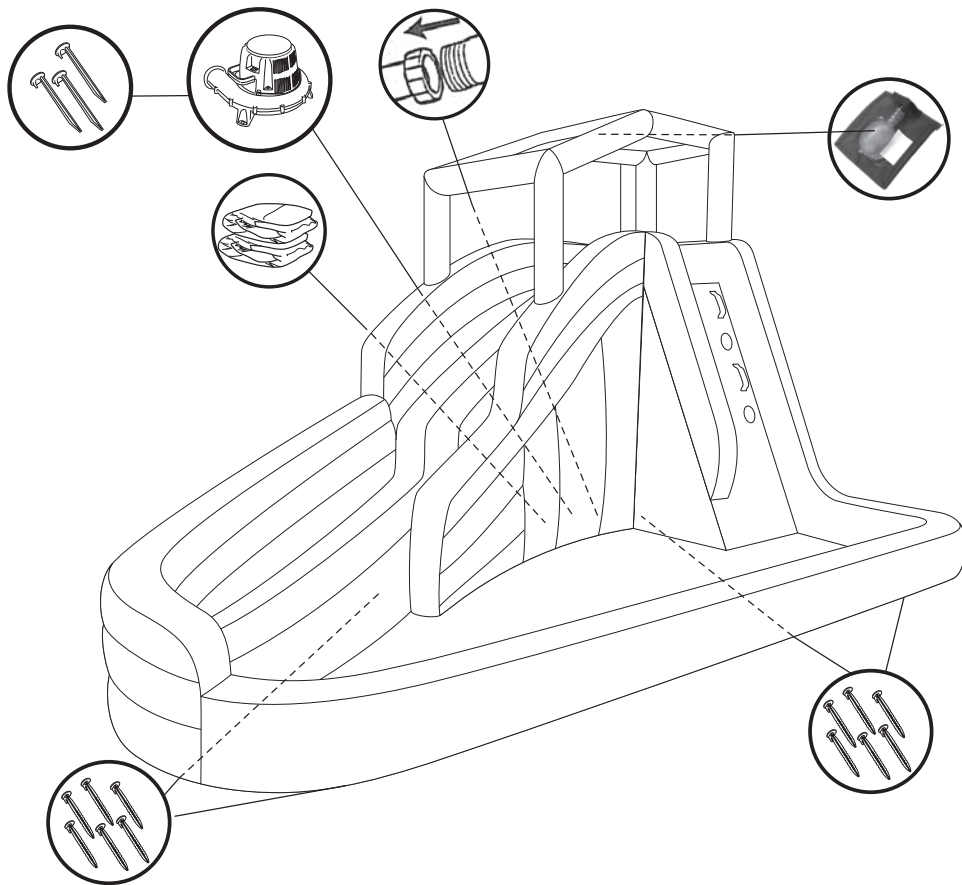

Connecting the Water Hose

1. Wet the curving water slide before connecting the garden hose to the hose adapter.
2. Locate the end of the Water Spraying Hose Assembly that should be attached to the inflated waterslide.
3. Attach the screw cap on the hose assembly to your garden hose.
4. Turn on the water slowly. It may take a few moments until water begins to spray.
5. Adjust the water pressure so that the water spray on the sliding surface of the curving slide, keeping the slide wet.

IMPORTANT WATER PRESSURE AND OPERATING INFORMATION

Water pressure can vary dramatically between cities. Please read the following to answer some common questions.

Areas of LOW WATER PRESSURE:

- **For maximum performance, it is recommended to use a 5/8 in (1.6cm) diameter garden hose.**
- **If water does not arch on the slide or shoot properly.** This is usually due to low water pressure, make sure the water is on all the way. As long as the slides are getting wet, it will be fun to use.
- **Long hoses reduce water pressure:** The longer the hose, the farther the water travels from the faucet thus reducing water pressure. In areas of low water pressure, this could affect performance of the water slide. Try using a shorter hose if you have one.

Areas of HIGH WATER PRESSURE :

- **If water shoots over the slide.** It is important that the water lands on the slide to keep it wet and slick.

How To Use

1. Follow all setup instructions to ensure the product has been set up properly.
2. Remove shoes, eyeglasses, and sharp objects before playing with product.
3. No flipping, piling, pushing or wrestling when playing with the product.
4. Only one child should be on the platform at a time.
5. Only one child should climb up the climbing wall at a time.
6. No diving of any sort is safe.
7. Get wet before sliding.
8. Do not stand on the top of the slide, on the slide rails, or on the slide itself.
9. Climb up the climbing wall of the slide and sit at the top of the slide with your feet pointing down the slide. Scoot forward and slide down the slide feet first.
10. To avoid the risk of serious injury or death, always slide with your feet first and never slide on your knees, stomach, or head first. Do not jump off or dive off the slide.
11. Only one child should slide down the slide at a time.
12. Never slide while facing direct sunlight.
13. To avoid possible serious injury, the sliding path and landing area must be clear of all obstacles and other users before sliding.
14. When sliding into the pool, the entering area should be clear of all submerged obstacles, non-submerged obstacles and other users.
15. Do not jump off or dive off the slide into the pool to avoid the risk of serious injury or death.
16. Do not jump off or dive off the climbing wall into the pool to avoid the risk of serious injury or death.

After Sliding

After you have finished sliding, scoot off the slide and stand up on the grass.

To avoid danger of tripping over the air intake tube and causing potential injury, do not walk on the side of the inflatable that has the blower motor attached. Always walk around the inflatable as shown with the dotted line in the diagram below.

Never stand, walk, or run on the slide as you may slip and injure yourself.

There should be a clear and unobstructed path along the walking paths. Make sure that the blower motor does not interfere with the walking paths.

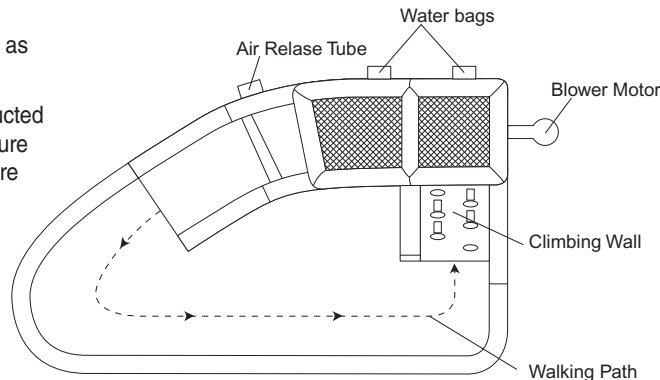

Emergency Evacuation

For emergency evacuation, users should evacuate through the exit and walk to a safe location as shown with the dotted lines in the diagram beside. To avoid danger of tripping over the air intake tube and causing potential injury, do not walk on the side of the slide that has blower motor attached.

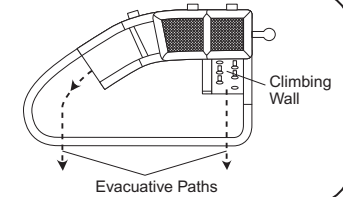

SAFETY CHECKLIST: READ BEFORE USING

SET UP:

1. **Before set up:** Check under and around the waterslide for sharp objects, rocks, sticks, lawn sprinklers or any other object that can cause injury or damage the waterslide. Set up on a flat lawn surface, free of depressions or high spots.
2. Use with manufacturer-supplied stakes ONLY.
3. Drop-Off Falls WATER PARK™ should be placed in a flat, clear area that is at least 10 ft (305cm) long and 10 ft (305cm) wide. There should be a safety area of at least 10 ft (305cm) on all sides that is clear of trees, walls, holes, garden equipment, pools and other objects that may pose a safety risk.
4. Do not use a damaged waterslide.
5. Wet entire slide before connecting the hose to the slide and before playing.
6. Blower and electrical cords should not pass under the inflatable waterslide and interfere with its operations.

USE:

1. Adult setup and supervision is required at all times. Adults should read instruction manual entirely and instruct children on proper use of this waterslide.
2. Get bathing suits or clothing wet before using Drop-Off Falls WATER PARK™. Remove all hard or sharp objects from person and pockets, such as toys, buckles, keys, jewelry, watches, etc.
3. For long periods of play, move waterslide occasionally to prevent depressions in ground underneath.
4. Check all ground stakes occasionally to make sure they stay secure and flat in the ground.
5. Do not leave water hose turned on when you are not using the slide. Only turn it on when playing.
6. While playing with the inflatable it is normal for some water to seep into the interior through the seam areas. IT IS IMPORTANT to completely dry prior to storing.
7. Anchor bags must be attached while playing.
8. The sliding path must be clear of users before sliding.

NOTE:

1. Check your local country or city regulations for requirements on securing the pool.
2. Secure the pool from unauthorized use.

To Deflate:

1. Remove all users from the Drop-Off Falls WATER PARK™.
2. Turn off and disconnect the water hose from the plug.
3. Before deflating, disconnect the anchor bags from the back of the inflatable slide, drain the water from the bags, allow to dry and properly store.
4. Drain water slide pool area by opening the water valve.
5. Completely dry off the slide by allowing it to stand inflated for at least 2 hour before wiping down with a dry beach towel or soft, absorbent cloth, noting deep pockets in the climbing wall and the splash pool.
6. Unplug the blower.
7. Disconnect the intake tube from the blower and place the blower in a safe place.
8. Open the air release tube and allow the inflatable slide to deflate completely. It should deflate on its own within 5 minutes. (Fig B1)
9. Remove the clear water tubing from the inflatable slide.
10. Remove the anchor stakes of the inflatable slide by pulling on the head of the stakes. **DO NOT** pull on the slide corners!
11. Allow the slide to dry completely before rolling up, which may take up to 48 hours. Be sure the pool and slide are free of dirt, leaves, sand, etc. This will lengthen the life of your slide.
12. Fold the inflatable slide in half, making sure that the release tube is parallel to the fold. Fold it in half 2 more times, parallel to the first fold. (Fig B2-B3)
13. Roll the inflatable slide tightly starting from the end opposite the intake and release tubes. (Fig B4-B5)
14. Roll the water slide tightly from one end to the other and avoid any creasing.

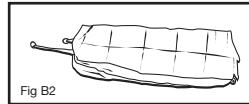
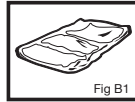

IMPORTANT:

Never store the Drop-Off Falls WATER PARK™ when wet. Allow to dry before rolling up. Move the slide everyday to prevent browning or damage to the lawn. Follow all previous instructions each time you set up the slide. Store slide in a secure place, away from children, to prevent suffocation.

Storage:

Slip the carrying bag over the rolled-up inflatable slide. Flip the bag and the slide over, close the bag, and store the slide and the blower in a dry place. Store the water slide in a secure place away from children to prevent suffocation. Never leave either the Drop-Off Falls WATER PARK™ or the blower outside when not in use. (Fig B6-B8)

To prevent mold and other damage to the slide, it is strongly advised to air out the product with the blower motor to ensure it is completely dry before folding up for storage. To extend the life of the water spraying hose assembly, store it in a adequately ventilated area. Do not store the water spraying hose assembly together with the slide.

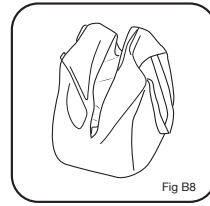
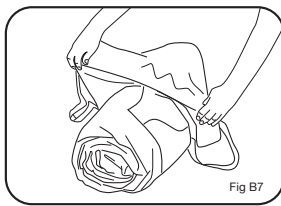
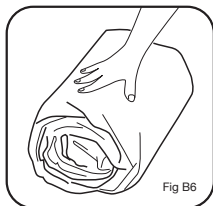

Grounding Instructions

This product must be grounded. In the event of an electrical short circuit, grounding reduces the risk of electric shock by providing an escape wire for the electric current. This product is equipped with a cord having a grounding wire with an appropriate grounding plug. The plug must be plugged into an outlet that is properly installed and grounded in accordance with all local codes and ordinances.

WARNING – Improper installation of the grounding plug is able to result in a risk of electric shock. When repair or replacement of the cord or plug is required, do not connect the grounding wire to either flat blade terminal. The wire with insulation having an outer surface that is green with or without yellow stripes is the grounding wire.

Check with a qualified electrician or serviceman when the grounding instructions are not completely understood, or when in doubt as to whether the product is properly grounded. Do not modify the plug provided; if it does not fit the outlet, have the proper outlet installed by a qualified electrician.

This product is for use on a nominal 120-V circuit, and has a grounding plug similar to the plug illustrated in sketch below. A temporary adapter similar to the adapter illustrated in sketches B and C may be used to connect this plug to a 2-pole receptacle as shown in sketch B when a properly grounded outlet is not available.

The temporary adapter shall be used only until a properly grounded outlet is installed by a qualified electrician. The green colored rigid ear, lug, or similar part extending from the adapter must be connected to a permanent ground such as a properly grounded outlet box cover. Whenever the adapter is used, it must be held in place by a metal screw.

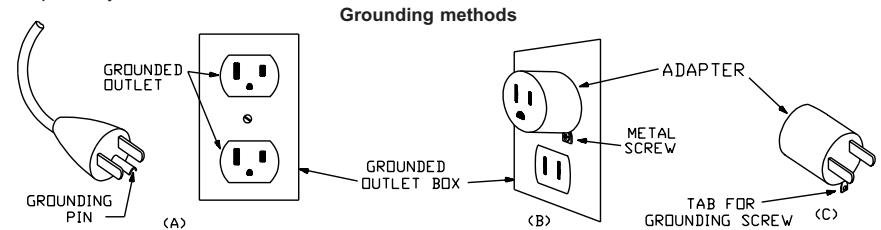

Maintenance of Drop-Off Falls WATER PARK™

1. Check the slide at regular intervals for holes, tears or other damage. **DO NOT** use a damaged slide. Use of a damaged slide could result in serious injury or death.
2. Check the water filled anchor bags at regular intervals for any signs of damage or deterioration. A damaged or deteriorated water filled anchor bags could cause the slide to become unstable which would be a significant safety hazard.
3. In addition to checking the product at a regular interval, be sure to complete a thorough check of the entire product at the beginning of each season or series of use.
4. If any component of the product is damaged or deteriorated, discontinue use and contact the manufacturer.
5. Regularly check the condition of the ground stakes that hold the slide in place. Damage to or deterioration of the stakes could result in the slide becoming unstable which could result in serious injury.
6. To keep the product clean, you can use a dry cloth or a cloth dampened with a neutral, non-inflammatory, nontoxic cleaning and sanitizing solution or pure water to wipe the surface of the slide or blower.
7. Use a dry cloth to clean the foot holes and remove debris after each play cycle. Make sure that there are no water and debris in the pocket steps before storing.

Blower Operating Instructions

Intended use:

This product is only to be used for inflating the Drop-Off Falls WATER PARK™. Household Use only.

Warning:

1. Electrical current requirements:110-120VAC,60Hz
2. The power supply to the blower should include a reliable earth terminal and current leakage protection device.
3. The power cord to the appliance should be clearly marked, so that persons using lawn mowers or other types of equipment are aware that there is a cord on the ground.
4. The blower should never be left unattended when in use. The appliance is not to be used by children.
5. No objects should cover the air intake when the blower is in use. Sand, small stones or other objects should not be allowed to be sucked into the blower.
6. Under no circumstances should a finger or any sharp object be inserted into the air intake.
7. The power supply to the blower should not be exchanged for any other type of supply. If the power supply is damaged, it should be repaired by a technician.
8. To avoid the danger of electrical shock, do not use the blower in the rain.
9. Do not use extension cords as this would present an electrocution hazard.
10. Do not leave the blower exposed to strong sunlight.
11. Children should not touch the blower. Children must not play on the product until the blower is properly installed.
12. Children should not attach foreign objects to the blower that are not specifically designed for use with the blower, such as, but not limited to jump ropes, clothesline, pet leashes, cables and chain as they may cause a strangulation hazard.
13. Sudden gusts of wind may lift the Drop-Off Falls WATER PARK™ off of the ground.
14. Blowers and electrical cords should be kept out of reach.

Installation:

1. Place the blower on the ground and then secure it by inserting the ground stakes into the holes in the base.
2. The blower should be installed in a well-ventilated location and on a level surface.
3. The air input of the Drop-Off Falls WATER PARK™ (the long yellow intake tube) is to be attached to the air output of the blower and secured in place with a cord.

Using the blower:

1. Plug the blower into a power supply.
2. To avoid electrical shock, never plug in or unplug the appliance with wet hands.
3. The power supply should be disconnected if the blower or the Drop-Off Falls WATER PARK™ needs to be transported or moved.
4. There is an ON/OFF switch on the blower body. Press " I " to switch on the blower, and press "0" to switch off the blower.

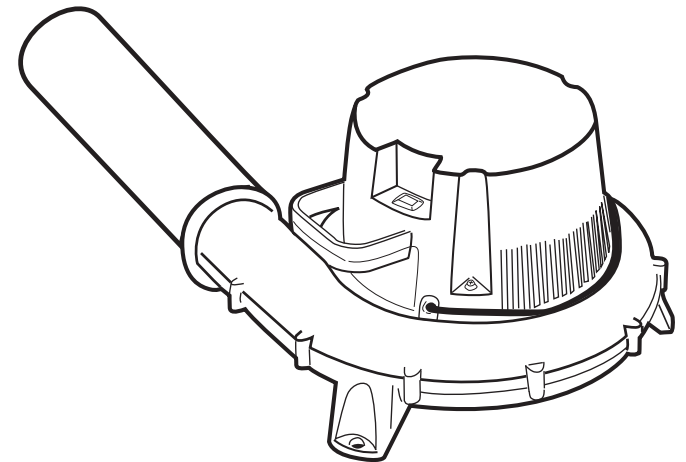

Attn: Each time the blower is used, a simple test with the Ground Fault Circuit Interrupter (GFCI) must be conducted.

1. Push the "Reset" button located on the GFCI receptacle, first to assure normal blower and GFCI operation.
2. Press "I" to switch on the blower.
3. Push the "Test" button located on the GFCI receptacle. The blower should go "OFF".
4. Push the "Reset" button again. The blower should go "ON" again.

The indicator on the GFCI receptacle will be red whenever the "Reset" button is pressed.

If the blower remains "ON" when the "Test" button is pushed, the blower or GFCI is not working properly. If blower or GFCI is not working properly, please call a qualified, certified electrician who can assess the situation.

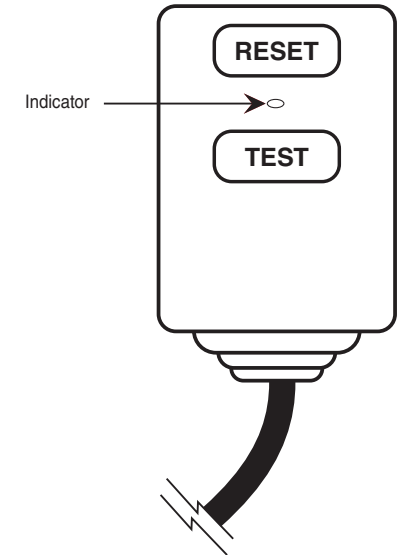

Maintenance and Storage:

1. To keep the product clean you can use a dry cloth or a cloth dampened with a neutral, non-inflammable, nontoxic cleaning and sanitizing solution or pure water to wipe the surface of the blower.
2. You should not clean the blower with a chemical solution as this may damage the coating and plastic parts.
3. Never clean the blower in water.
4. Never store the blower outside. Keep it in a dry indoor place unreachable by children.
5. Regularly check the condition of the blower stakes. Damage to or deterioration of the stakes could result in the blower becoming unstable which could result in serious injury.
6. Regularly check the condition of the power cord. Damage to or deterioration of the cord could cause a serious electrocution hazard. If the cord is damaged or deteriorated, immediately discontinue use of the blower and contact the manufacturer.
7. This blower with Auto-Reset Protector, if the motor over heated, the protector will trip to protect your safety. Turn off the blower and let it cool down. Then, you can use it again. Please follow the instruction carefully to avoid any wrong operation that will cause overheating.
8. To keep the power cord in good condition, hand-supported product when carry the power cord, and do not twisting the cord, keep it dry and store it dry.

ALL NEW MATERIAL. Surface Clean Only. Electrical ratings: 110-120VAC, 60Hz, 4.2A



WARNING - Electrocution Hazard
DO NOT USE EXTENSION CORDS
WITH THIS PRODUCT.

NOTE:
The maximum wind speed for operations of the inflatable shall be 20 mph.

Part List

1. 1 x Inflatable Water slide.
2. 1 x Blower Motor.
3. 1 x Water Spraying Hose assembly.
4. 3 x Blower Stakes. (Orange)
5. 5 x Waterslide Stakes + 1 Extra. (Yellow)
6. 1 x Carrying bag.
7. 2 x Water Bags.
8. 4 x Repair Patch.

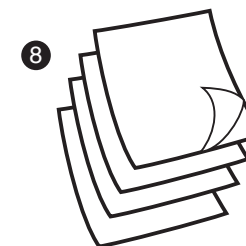
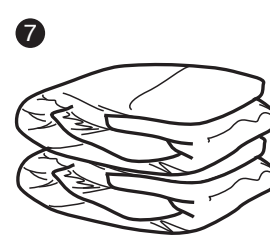
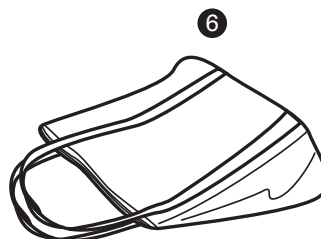
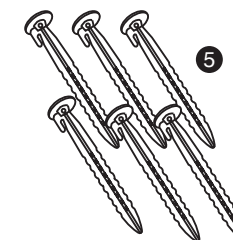
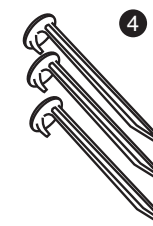
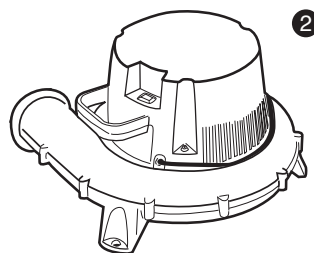
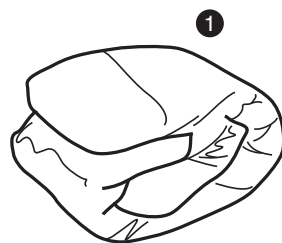

DO NOT RETURN TO STORE

THIS PRODUCT CANNOT BE RETURNED
FOR A REFUND AFTER
IT HAS BEEN UNPACKED AND USED.

FOR QUESTIONS OR PROBLEMS WITH THIS PRODUCT
PLEASE EMAIL BELOW ADDRESS
FOR EXPEDITED ASSISTANCE

CUSTOMERSERVICE@TOYSINQUIRY.COM

OR

1-800-434-6178

TOYQUEST
02639

PLEASE RETAIN THIS INFORMATION FOR FUTURE REFERENCE.
COLORS AND CONTENTS MAY VARY.
PUTOU INDUSTRIAL AREA,
HUZHEN TOWN, BOLUO,
HUIZHOU, CHINA
ALL RIGHTS RESERVED
MADE IN CHINA
www.toysinquiry.com